

# Aluminium Bifold Doors

## Help and Compare Guide

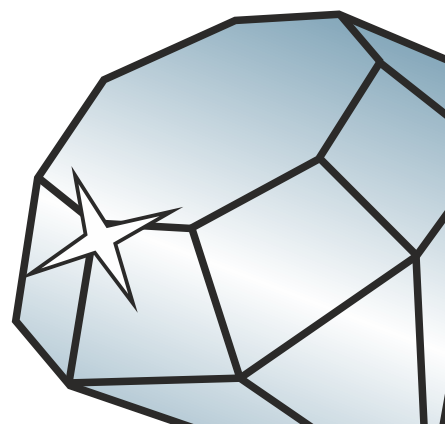

DURATION  
WINDOWS



# Terminology

## Terms We Use For Our Doors

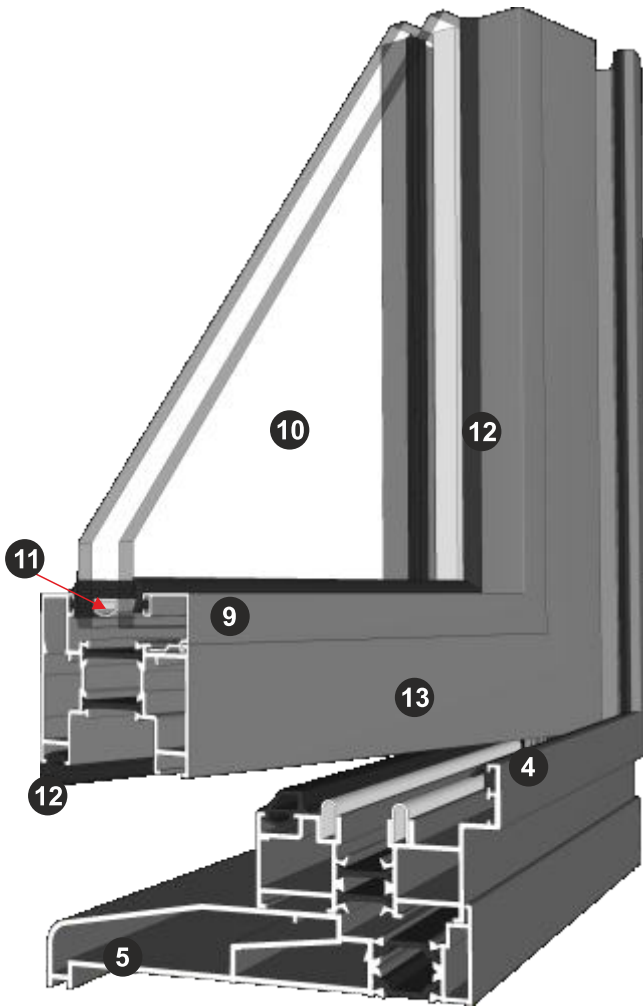

- 1) Finger Shoot Bolt: The locking system used on a slave door.
  - 2) Lever Handle: A handle used on a traffic door.
  - 3) Intermediate Handle: A handle used on the folding panels to operate the lock.
  - 4) Up Stand: An extended leg which the doors close up against.
  - 5) Projection Cill: An optional section of metal that projects forward away from the door and helps to protect your brick work. This is used at the bottom of the door to the outside.
  - 6) Cill Horns: When the cill is cut longer over your brick work.
  - 7) Cut Flush: When the cill is cut the same size as the product.
  - 8) Trickle Vents: These are optional to the product and fit into the head. They allow a small flow of air into the room. An extra section of metal called an extension packer will be used.
  - 9) Glazing Beads: The section of metal that holds the glass in place along with the wedge gaskets.
  - 10) Glazed Unit: The glass section for the doors.
  - 11) Spacer Bar: The section between the two glass sheets that keep them apart.
  - 12) Gaskets: The rubber section used in multiple areas as weather seals.
  - 13) Sash / Leaf: The section that forms the opening panel of the door.
  - 14) Quad Trim: A 15mmx15mm aluminium trim with a radius edge.
- Draught / Wool Pile: The furry section used on some doors between the frame and sash.
- Profile: What we call the section of metal that make the products.
- Sightlines: The sizes of the sections / profiles of the finished door that will obstruct the view.

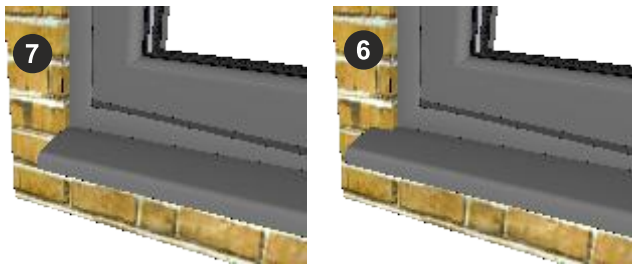

# Terminology

## Terms We Use For Our Doors



### 1) Traffic Door:

These are independent doors that operate like a normal front door.

Not all bifolds will have a traffic door. You will have a traffic door if you have an odd number of panels moving in one direction.

Even panel doors such as a 4 panel bifold will not have a traffic door when moving in one direction. To have a traffic door on a 4 panel bifold you will need to split the panels 3-1.



### 2) Slave Door:

These are secondary independent doors that only operate after a traffic door has been used - like French doors.

You will have a slave door if 2 traffic doors are next to each other. e.g. a 6 panel door being split 3-3 resulting in 2 traffic doors in the centre.



### 3) Intermediate Door: The folding set of doors.

### 4) Jamb:

The sides of the door.

### 5) Head:

The top of the door.

### 6) Threshold:

The bottom section of the door you will walk over.



# Comparing Our Doors

## Emperor Concealed

- Sleek modern look - hinges are concealed within frame
- 66mm rebated threshold - fully weather rated
- 28mm low weather rebated threshold with optional clip in cill
- Available with PAS24 security upon request
- Glass to glass sightline of 135mm
- Child friendly intermediate handle - once locked can not be moved or played with



## Durafold 1000

- Panel widths of up to 1200mm and heights of up to 2750mm
- 15 & 20mm flush threshold or 49.5mm rebated threshold
- Glass to glass sightline of 132mm
- Exceptional array of security features as standard
- Low U-values of 1.7 W/M<sup>2</sup>K or upgrade to 1.5 W/M<sup>2</sup>K
- Finger safe gaskets to folding panels & Optional D Handles



## Durafold Slimline Plus

- Slimmest sightlines - less metal and more glass
- 54mm rebated threshold
- Glass to glass sightline of 94mm
- Exceptional array of security features as standard
- Low U-values of 1.7 W/M<sup>2</sup>K or upgrade to 1.5 W/M<sup>2</sup>K
- Finger safe gaskets to folding panels & Optional D Handles



## Continental

- Panel widths of up to 1200mm and heights of up to 2750mm
- 34mm flush threshold or 54mm rebated threshold
- Glass to glass sightline of 140mm
- Available with PAS24 security upon request
- Low U-values of 1.7 W/M<sup>2</sup>K or upgrade to 1.5 W/M<sup>2</sup>K
- Finger safe gaskets to folding panels
- Available as a corner post door with floating post External corner, Rebated threshold, Open out only & limited configurations. See full brochure for details.



## Continental Plus

- Panel widths of up to 1200mm and heights of up to 2600mm
- Low U-values of 1.7 W/M<sup>2</sup>K or upgrade to 1.5 W/M<sup>2</sup>K
- 47mm rebated threshold
- PAS24 security as standard
- Slim Glass to glass sightline of 122mm
- Unique flush pop out T-handle on intermediate panels



## Heritage Bifold

- Steel Look Heritage Bifold Door
- 54mm rebated threshold
- Glass to glass sightline of 94mm
- Choice of Astragal Bars (19mm, 25mm or 41mm)
- Optional Kick Plates
- Low U-values of 1.7 W/M<sup>2</sup>K or upgrade to 1.5 W/M<sup>2</sup>K.



## Common Points

- Use low maintenance, hard wearing powder coated aluminium.
- Are bottom hung and run on double stainless steel tracks.
- Open in or out.
- Wide range of colours including over 200 RAL finishes.
- Durafold 1000, Durafold Slimline Plus & Emperor can also be painted in 15 Textured colours.

# Thresholds

The threshold is the bottom section of the door that you cross over to enter or leave the property. All bifold doors will have one of these but they do come with varying options. The main descriptions are rebated threshold or low threshold.

## Rebated Threshold

Rebated thresholds have an up stand to the opposite side to where the door is opening making it fully weather rated (eg, open out doors - rebate to inside). They can be sunk into the floor level to create a neater finish with less trip hazards; as long as the building / floor levels allow. Although there is a possibility of sinking the thresholds - this will always result in different floor levels from inside to outside.



\*Durafold 1000 rebated threshold shown.

## Low (flush) Threshold

Low thresholds are the same size inside & outside making it not weather rated. These can be sunk into the floor to create a seamless look from inside to outside. These are not weather rated due to the fact the rebate is removed and draught pile is used between the sash and threshold. We can not guarantee that in extreme cases, wind and driving rain will not penetrate one or more levels.



\*Durafold 1000 20mm low threshold shown with optional clip in ramps.

## Low Rebated Threshold

Low rebated thresholds are slim but with a small up stand to the back which provides weather protection making it weather rated. This threshold can be sunk into the floor to create a more flush look but will still result in a small difference from inside to outside. Emperor Concealed only.

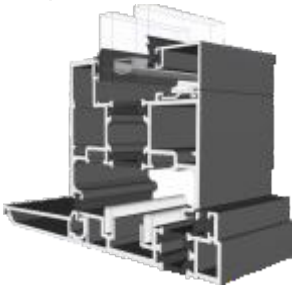

\*Shown with optional clip in cill.

## Rebated Threshold With Integrated Cill

Rebated threshold with an integrated cill will be fully weather rated due to the up stand (like the rebated threshold). This can be sunk into the floor level if the project allows, but due to the integrated cill, will always result in a different level inside to outside. Note this threshold is limited to the Durafold 1000.

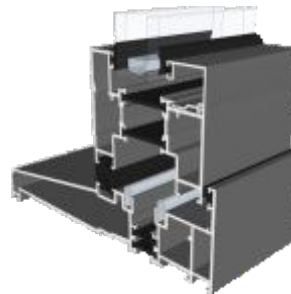

Threshold Height Comparison						
Threshold Type	Emperor Concealed	Durafold 1000	Durafold Slimline Plus	Continental	Continental Plus	Heritage Bifold
Rebated	66mm Fully Weather Rated	52mm Fully Weather Rated	55mm Fully Weather Rated	54mm Fully Weather Rated	47mm Fully Weather Rated	55mm Fully Weather Rated
Rebated With Separate Cill	91mm Fully Weather Rated	77mm Fully Weather Rated	80mm Fully Weather Rated	79mm Fully Weather Rated	72mm Fully Weather Rated	80mm Fully Weather Rated
Low	N/A	20mm or 15mm Not Weather Rated	N/A	34mm Not Weather Rated	N/A	N/A
Low Rebated	28mm Weather Rated	N/A	N/A	N/A	N/A	N/A
Rebated With Integrated Cill	N/A	52mm Fully Weather Rated	N/A	N/A	N/A	N/A

Please note all sizes above are based on the internal measurement of the threshold on an open out door.

# Traffic Doors and Configurations

Traffic doors operate like a normal front door.

Traffic doors are only achievable when a bifolding door is configured with an odd amount of panels moving in one direction - such as 3 panels. If the configuration results in an even amount of panels such as 4 then this would not have a traffic door unless it was split to result in an odd amount of panels such as a 4 panel split 1-3. Please see images below to show example configurations:

**1 & 2 Panels**

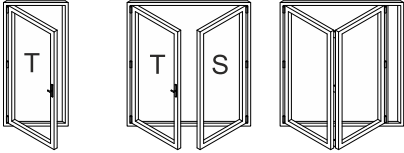

Key	
T	Traffic Door
S	Slave Door

Please note that all configurations shown can be reversed / mirrored.

Doors can open in or out, although open out is the more popular design.

**3 Panels**

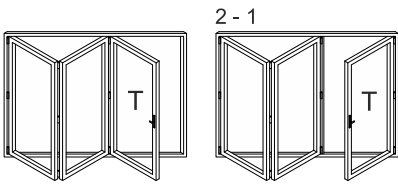

**4 Panels**

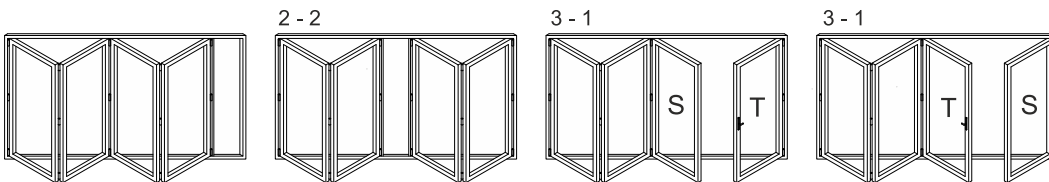

**5 Panels**

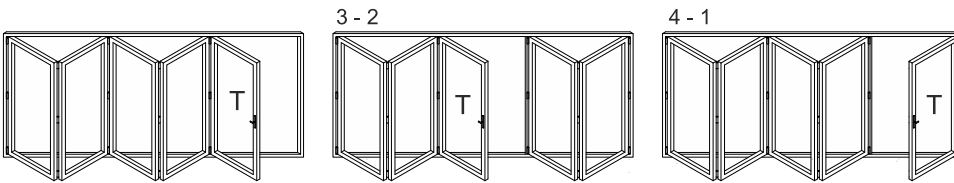

**6 Panels**

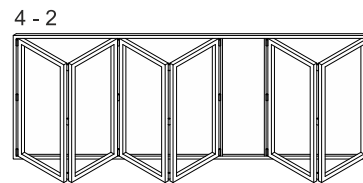
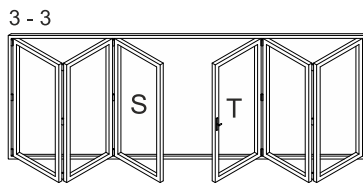
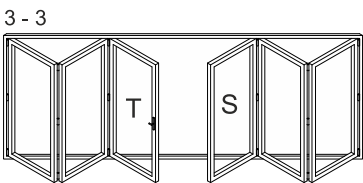
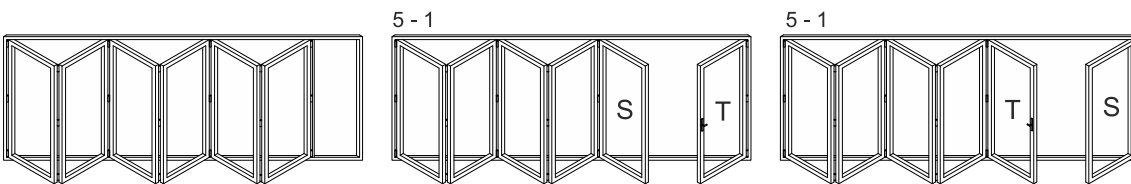

**7 Panels**

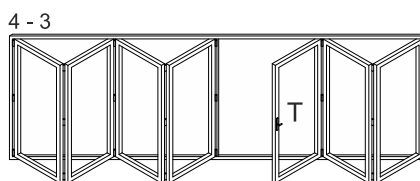
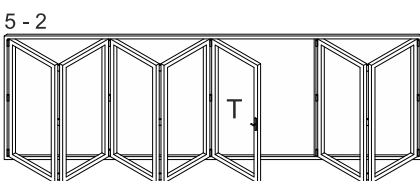
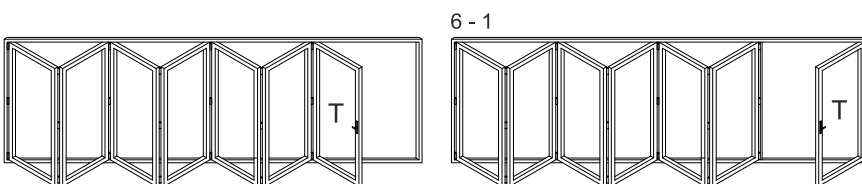

# Sash Profile, Glazing Beads, Hinges & Gaskets

## Sash Profile

The door sash profile is available in two designs externally of square or rounded.

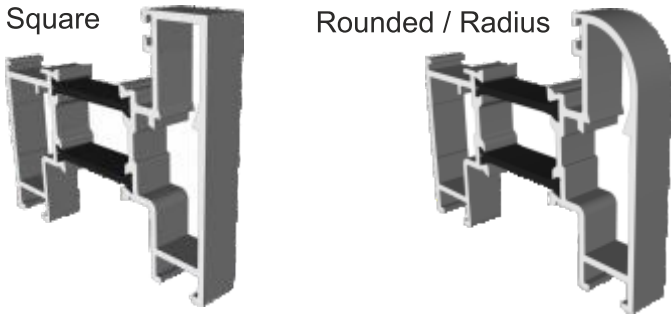

## Glazing Beads

The glazing beads for most doors are available in either a square or chamfered design. These are always on the inside of the bifolding doors.



## Hinges

Depending on the door system you choose there are a few options to consider when choosing gaskets and hinges. Take into consideration that the hinges run in line with the gaskets. Below are some examples of different colour combinations of gasket, door and hinge. If you are using our Emperor Concealed the hinges are a black standard only and are not visible when closed.

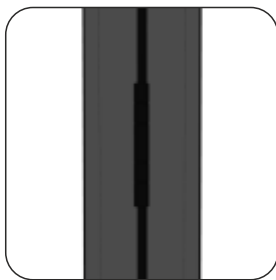

	Door	Hinge	Gasket
Colour	Grey	Standard Black	Black

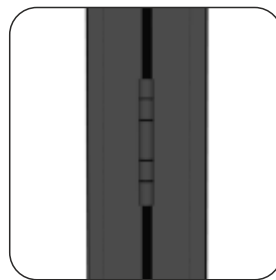

	Door	Hinge	Gasket
Colour	Grey	Custom RAL	Black

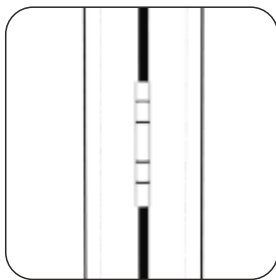

	Door	Hinge	Gasket
Colour	White	Standard White	Black

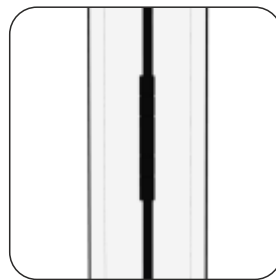

	Door	Hinge	Gasket
Colour	White	Standard Black	Black

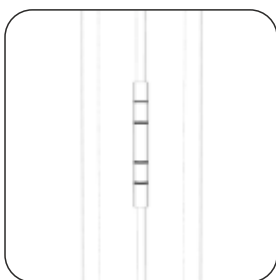
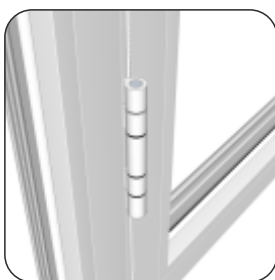

	Door	Hinge	Gasket
Colour	White	Standard White	White*

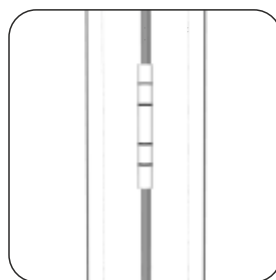
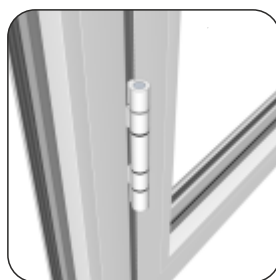

	Door	Hinge	Gasket
Colour	White	Standard White	Grey

\* White gaskets available inside only

# Glass Options

We can supply our doors glazed with a range of high quality glass or unglazed if you wish to source your own. Our Standard glass is clear toughened 28mm sealed unit, 90% argon filled with a warm edge spacer bar. We also offer a range of other specialist glass at an extra cost.

*Toughened Safety Glass*



Toughened safety glass is high strength and when it breaks it doesn't splinter, it crumbles into small granular chunks.

*Laminated Security Glass*



The glass is held in place by a high strength interlayer, which helps keep the layers of glass bonded even when broken.

*Self Clean & Solar Control*



This glass has self cleaning properties to the outside only and also works to block and reflect the sun's harmful UV rays. Provides a cooler, safer internal environment.

*SN - Solar Control Glass*



This solar control glass has a U-Value of 1.1  $W/M^2K$  for high thermal efficiency, and works to block and reflect the sun's harmful UV rays, keeping you cooler in the summer and warmer in the winter.

*Self Cleaning Glass*



This glass has a clear self cleaning coating (on the outside only) that uses UV light to break down dirt, allowing rain water to wash the dirt away.

*Planitherm One - Low U-value*



This glass is a clear sealed unit that will provide a useful improvement in thermal efficiency compared to standard low-E glass. It has a centre pane U-value of just 1.0  $W/M^2K$  in a 24mm unit.



# Handle Options

## Emperor Concealed

### Traffic Door



White Gloss  
Matt Black  
Chrome  
Brushed Stainless Steel  
Dark Grey 7016 Matt  
Vulcan Black  
Trend Textured

### Traffic Door SBD



White Gloss  
Matt Black  
Chrome  
Anodised Silver

### Intermediate Panel



White Gloss\*  
Matt Black\*  
Chrome  
Brushed Stainless Steel  
Dark Grey 7016 Matt\*  
Vulcan Black\*  
Trend\*

\*Intermediate handles come with matching or chrome trim.

## Durafold 1000

### Traffic Door



White Gloss  
Matt Black  
Chrome  
Brushed Stainless Steel  
Dark Grey 7016 Matt

\*Handles may differ in style depending on colour.

### Intermediate Panel



White Gloss  
Matt Black  
Chrome  
Brushed Stainless Steel  
Dark Grey 7016 Matt

### Optional D-Handle



White Gloss  
Matt Black  
Chrome\*

\*on this option main hinge is black.

## Continental

### Traffic Door



White Gloss  
Black Semi-Gloss  
Chrome  
Silver Painted

### Intermediate Panel



White Gloss  
Black Semi-Gloss  
Chrome  
Silver Painted

## Continental Plus

### Traffic Door



White  
Black  
Silver

### Intermediate Panel

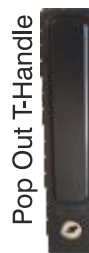

White  
Black  
Silver

## Durafold Slimline Plus

### Traffic Door



White Gloss  
Matt Black  
Chrome  
Dark Grey 7016 Matt  
Trend Textured

### Intermediate Panel



Key Locking  
White Gloss  
Black  
7016  
Brushed Steel



Non Key Locking  
White Gloss  
Black  
7016  
Chrome  
Dur Colours  
Trend Colours

### Optional D-Handle



White Gloss  
Matt Black  
Chrome\*

\*on this option main hinge is black.

# Blinds

## Magnetic Manual Blinds - Integrated in glass

Integrated blinds are Venetian style blinds that are actually installed inside the double glazed sealed unit. Our integrated blinds are manufactured to the internal size of the sealed unit, fitting neatly between the two sheets of glass. The slat raising, lowering and tilting function is achieved using a magnetic transmission through the glass, thereby guaranteeing the unit's hermetic seal.

This integrated blind system is very simple and easy to use and functions with surprising grace and speed. Raise, lower and tilt functionality is achieved by simply sliding the push blocks along the side border rails.

The borders are available in Anthracite, Grey, Beige and White.



### Slat Colours



## Electronic Controlled Blinds - Integrated in glass

Our integrated Venetian style blinds fit neatly inside the double glazed sealed units not only protecting the blinds but keeping them dust and maintenance free. The slats are designed to not only raise and lower the full height of the door panels, but they can be tilted so that you have maximum control over the amount of light entering your room.

The electronic blinds are battery operated using the controller provided which means no costly electricians are needed to install the units. The controllers that provide the power are simply magnetised to the small pad applied to the sealed unit and are charged using the solar panel which is attached to the outside of the panel. Controllers are designed to operate the blinds with raising, lowering and tilting functions.

These blinds do not have any large side rails unlike the manual versions.

This system provides a remote control as standard, which can control 90+ blinds.

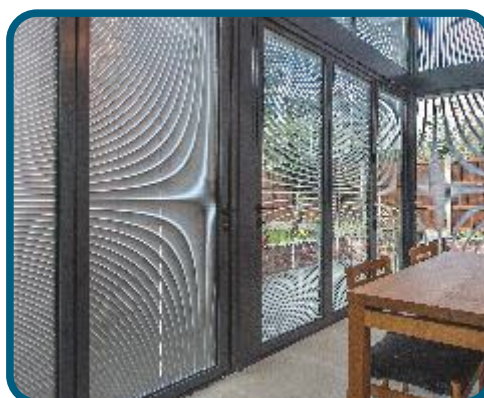

### Slat Colours



Integrated blinds in the glass are only available when using a standard 28mm unit configured with two sheets of 4mm glass and a 20mm gap between the glass. Any laminated or 24mm units can not have blinds in them.

# Fixing & Delivery Areas

## Delivery



All of our vehicles carry the latest GPS navigation systems and all of our drivers can be contacted by mobile phone. Using our satellite van tracking systems we are able to keep track on our delivery vehicles 24/7. We can deliver straight to your door or we can deliver to a specified site address.

Our standard delivery area is shown on the map opposite (Zones A, B & Dark blue areas).

If you require delivery outside of our standard delivery area then please contact us for advice.

## Fixing By Duration

Installing bi-folding doors requires specialised care and attention. If you are a trade company or individual that doesn't want the hassle of installing bi-folding doors, then why not get us to supply, deliver and 'fix' your bi-fold doors into an existing and fully prepared aperture.

When 'fixing' our doors we will install the doors with due care and attention, toe and heel the panels, fully test the doors, and leave the doors in a perfect working condition.

Our fixing service is available within areas A + B on the map (See map).

Please note that our 'fixing' service is only available for our bi-folding doors and is by no means a full installation service. This service does not include (but not limited to) mastic, sealing outside, plastering, rendering, making water tight, removing existing doors or preparing the hole.

Fixings can be undertaken with or without a survey. Note a size disclaimer will need to be signed for any fixing where Duration Windows have not done a survey.

## Survey By Duration

We will come out to site and survey the prepared aperture, take responsibility for the manufacturing sizes and the fixing of the doors within the hole. We will guarantee our workmanship and the doors. Please note we only provide a survey if we are doing a fixing for the doors.

Please make sure all involved parties; builders, homeowner and other trades are aware of what work is and is not done by Duration Windows. Please contact the Bifold door area of our Sales Department for more information.

### **Main Office & Factory**

Units 4-5,                    t: 01268 681612 (20 lines)  
Charfleets Road,        f: 01268 510058  
Canvey Island,         e: sales@duration.co.uk  
Essex. SS8 0PQ         w: www.duration.co.uk

### **Product Showroom**

Unit 1 Casino Parade,    t: 01268 695100  
Eastern Esplanade,  
Canvey Island,            SatNav Directions  
Essex. SS8 7FJ            Use: SS8 7DN.